

**Features:**

- Pass Band : DC~40GHz
- Attenuation : 7dB
- Size : 0.6x0.75x0.1mm

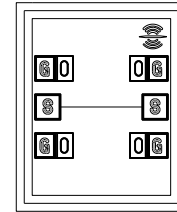

**Structure**

**Absolute Maximum Ratings**

- Max. Input Power : +33dBm
- Storage Temperature : -65 ~ +150Deg.C
- Operating Temperature : -55 ~ +125Deg.C



ELECTROSTATIC SENSITIVE DEVICE  
OBSERVE HANDLING PRECAUTIONS

**Electrical Specifications (T<sub>A</sub>=+25Deg.C, 50Ω system)**

Parameter	Condition(GHz)	Min.Value	Typical Value	Max.Value	Unit
Frequency Range		DC-40			GHz
Attenuation	DC-12 12-26.5 26.5-40	-	7±0.20 7±0.20 7±0.40	-	dB
Return Loss	DC-12 12-26.5 26.5-40	30.0 22.0 18.0	-	-	dB

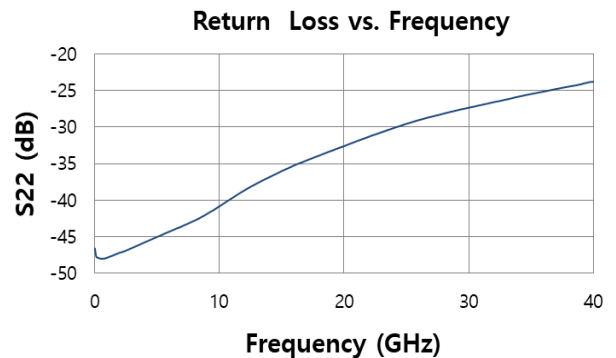
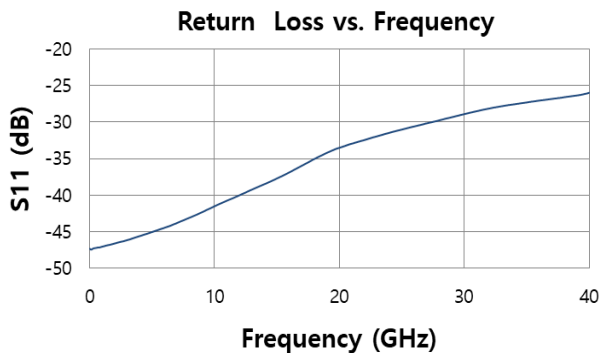
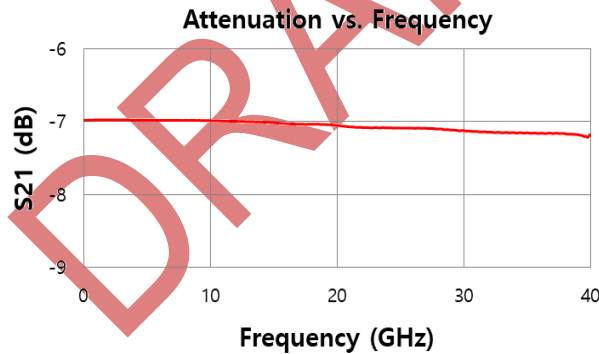

**Size**

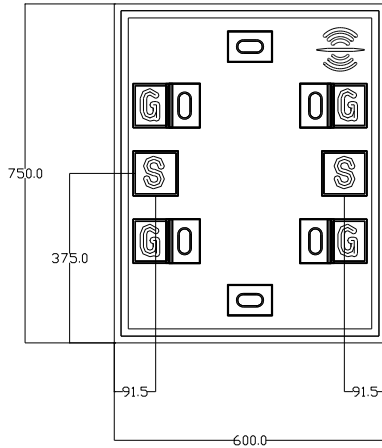

Remarks:Unit :  $\mu\text{m}$ , Tolerance :  $\pm 0.05\text{mm}$

1. Chip bottom is gold plated and grounded.
2. Bonding pressure points are gold plated, pressure points sizes are 0.1x0.1mm.
3. Don't bond on the through holes.

**Applications**

1. Assembly and Bonding Diagram.

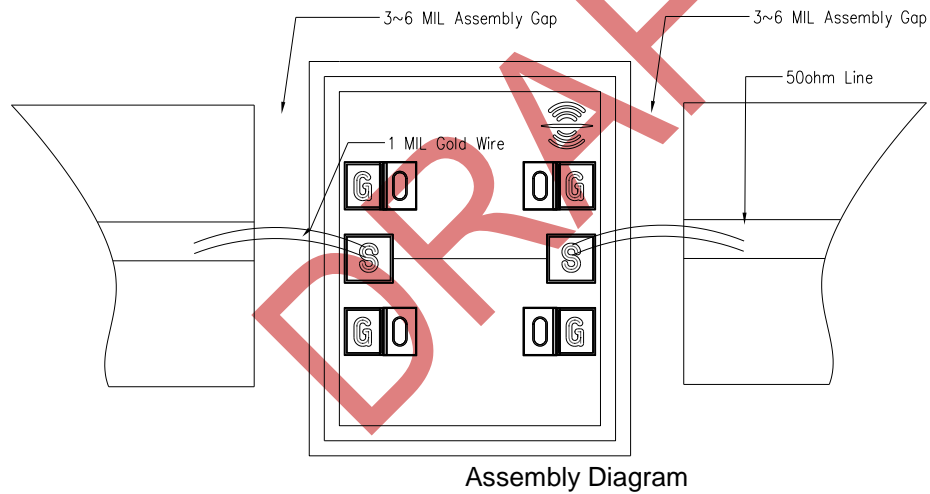

2. Bonding Diagram.

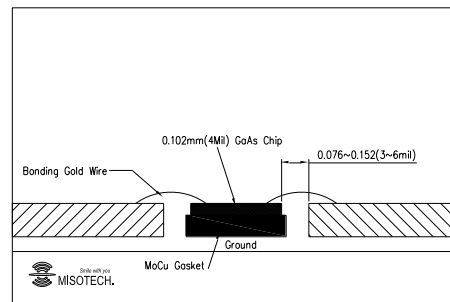
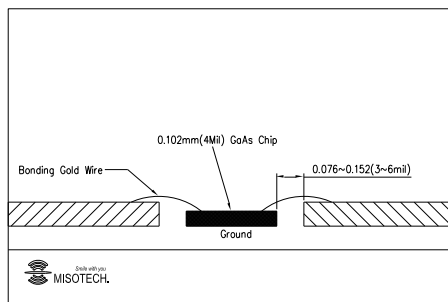

Note : Ceramic substrate should be close to the chip to shorten bonding wire.

Typical assembly gap is 0.076-0.152mm (3-6mils).

**Mounting and Bonding Recommendations**

MISOTECH MMICs should be attached directly to a ground plane with conductive epoxy. The ground plane electrical impedance should be as low as practically possible. This will prevent resonances and permit the best possible electrical performance. Datasheet performance is only guaranteed in an environment with a low electrical impedance ground.

**Mounting** - To epoxy the chip, apply a minimum amount of conductive epoxy to the mounting surface so that a thin epoxy fillet is observed around the perimeter of the chip. Cure epoxy according to manufacturer instructions.

**Wire Bonding** - Ball or wedge bond with 0.025 mm (1 mil) diameter pure gold wire. Thermosonic wirebonding with a nominal stage temperature of 150 °C and a ball bonding force of 40 to 50 grams or wedge bonding force of 18 to 22 grams is recommended. Use the minimum level of ultrasonic energy to achieve reliable wirebonds. Wirebonds should be started on the chip and terminated on the package or substrate. All bonds should be as short as possible <0.31 mm (12 mils).

**Circuit Considerations** – 50 Ω transmission lines should be used for all high frequency connections in and out of the chip. Wirebonds should be kept as short as possible, with multiple wirebonds recommended for higher frequency connections to reduce parasitic inductance. In circumstances where the chip more than .001", thinner than the substrate, a heat spreading spacer tab is optional to further reduce bondwire length and parasitic inductance.

**Handling Precautions**

**General Handling:** Chips should be handled with a vacuum collet when possible, or with sharp tweezers using well trained personnel. The surface of the chip is fragile and should not be contacted if possible.

**Static Sensitivity:** GaAs MMIC devices are subject to static discharge, and should be handled, assembled, tested, and transported only in static protected environments.

**Cleaning and Storage:** Do not attempt to clean the chip with a liquid cleaning system or expose the bare chips to liquid. Once the ESD sensitive bags the chips are stored in are opened, chips should be stored in a dry nitrogen atmosphere.

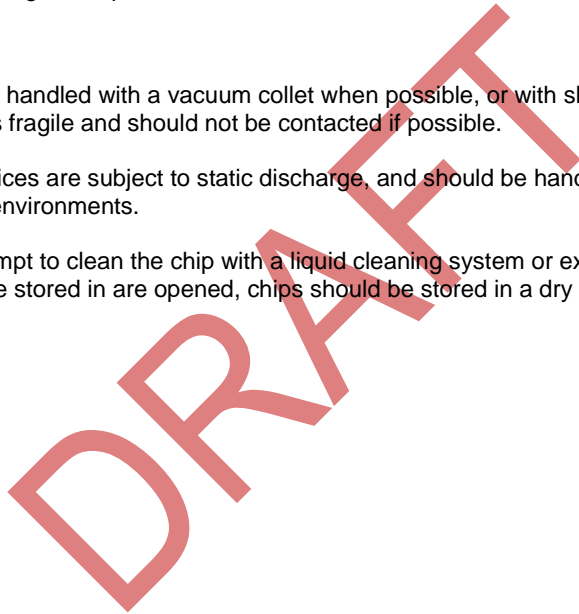

**Model Code**

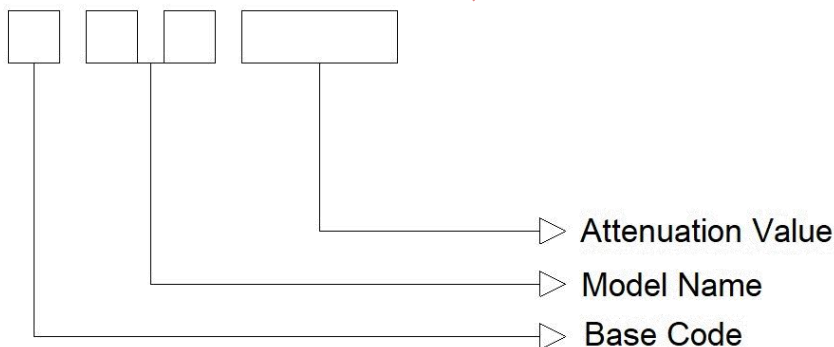

**Remark**

1. Base Code (`M` M is an abbreviation of MISO)
2. Model Name (ex. `Attenuator` abbreviation is an AT)
3. Attenuation Value